

3/4 varv / of a turn / Umdrehung /
d'un tour / kierrosta / omdrejning - 2K

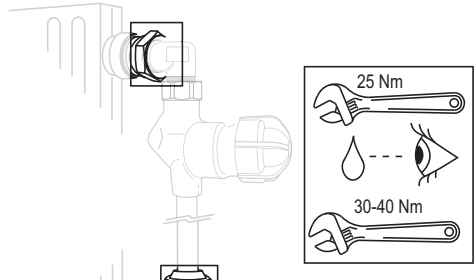

Kan även installeras i kylanläggning, men endast i kombination med VAO/VAC.
Can also be installed in refrigerating plants, but only combined with VAO/VAC.
Kann auch in Kuhl Anlagen installiert werden, jedoch nur in Kombination mit VAO/VAC.
Peut aussi être monté dans une installation de refroidissement, mais seulement en combinaison avec VAO/VAC.
Venttiiliä voidaan käyttää myös jäähdytysjärjestelmissä, mutta varustettuna toimilaitteella VAO/VAC.
Kan også installeres i køleanlæg, men kun i kombination med VAO/VAC.

Förinställning, Pre setting, Voreinstellung, Préréglage, Esisäätö Forindstilling

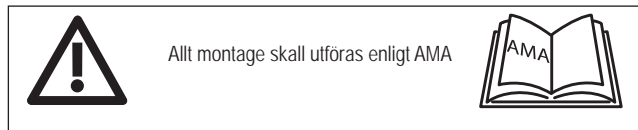
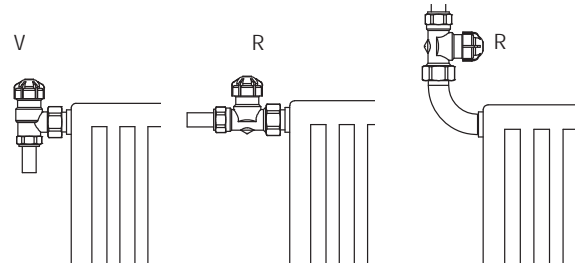
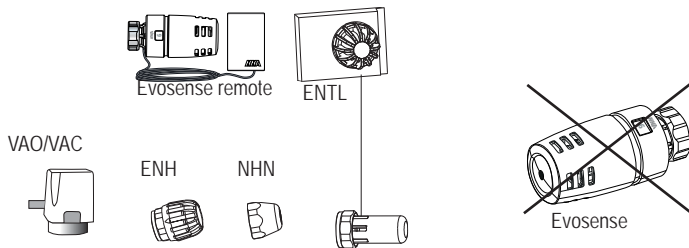
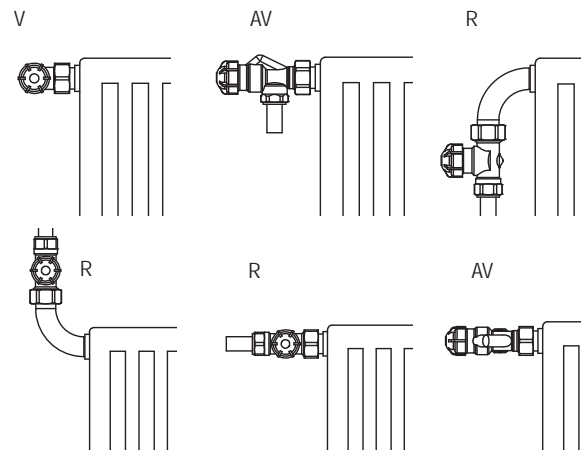
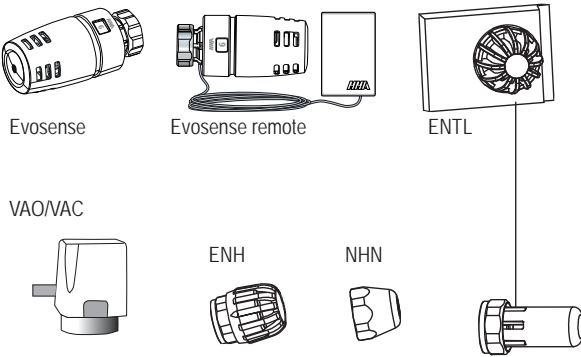
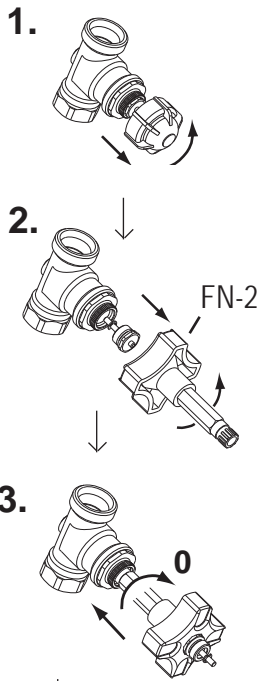

Öppningsvarv **N** gäller för:
Turns open **N** valid for:
Öppningsumdrehungen **N** gilt für:
Tours d'ouverture **N** concernant:
Avauskierrokset **N** :
Åbningsomdrejning **N** gælder for:

Alt.1

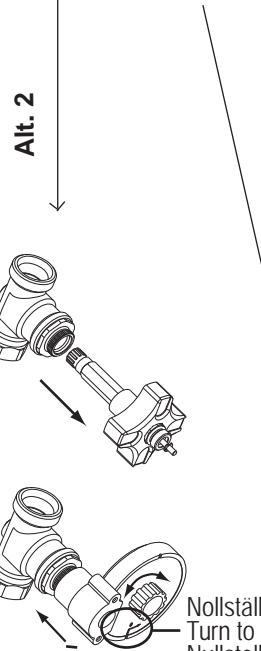

Öppningsvarv **N** gäller för:
Turns open **N** valid for:
Öppningsumdrehungen **N** gilt für:
Tours d'ouverture **N** concernant:
Avauskierrokset **N** :
Åbningsomdrejning **N** gælder for:

Alt. 2

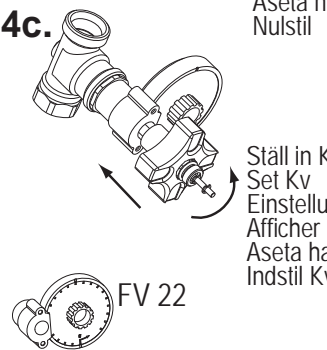

Nollställ
Turn to zero
Nullstellung
Mettre à zero
Aseta näyttötaulu nolnaan
Nulstil

Ställ in Kv
Set Kv
Einstellung Kv
Afficher Kv
Aseta haluttu Kv
Indstil Kv

FV 22

Inställning med verktyg FV 22 gäller endast 2K.
Setting by means of the FV 22 tool only valid for 2K.
Voreinstellung mit Werkzeug FV 22 gilt nur für 2K.
Réglage à l'aide de l'outil FV 22 valable seulement pour 2K.
FV 22 esisäätötyökalua käytetään vain 2K.
Indstilling med værktøjet FV 22 gælder kun for 2K.

